

ALUMINIUM BOTTOM RAIL

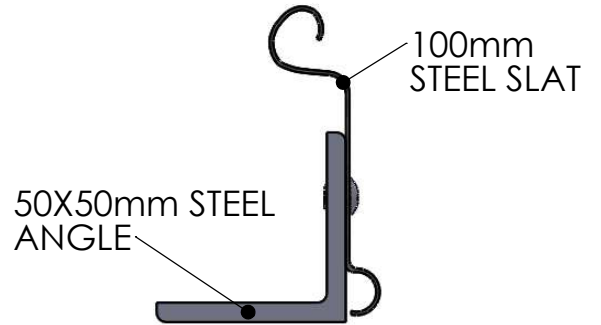

STEEL ANGLE + RHS BOTTOM RAIL

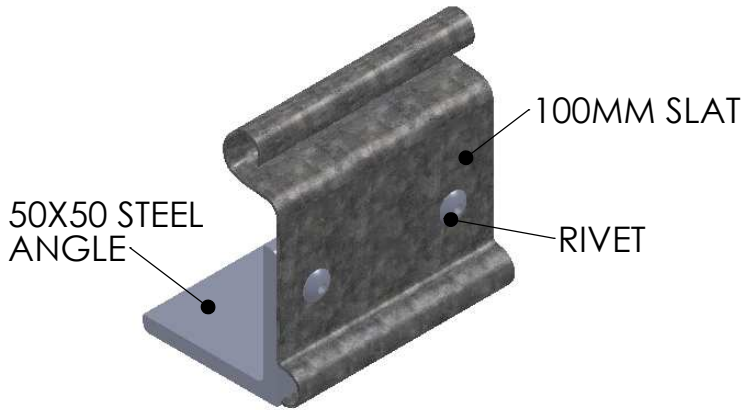
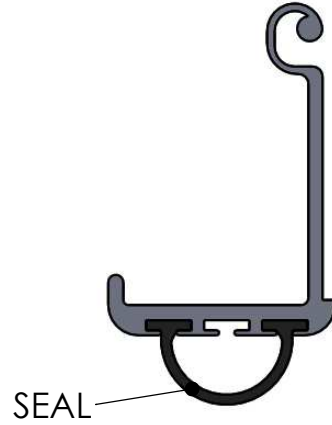
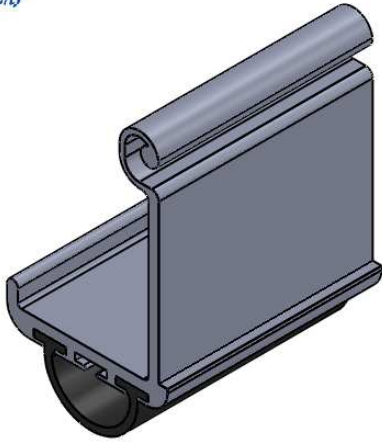
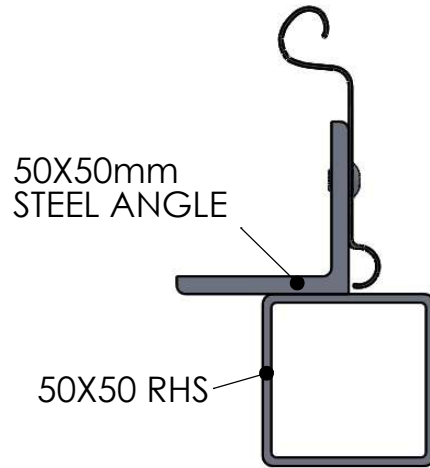
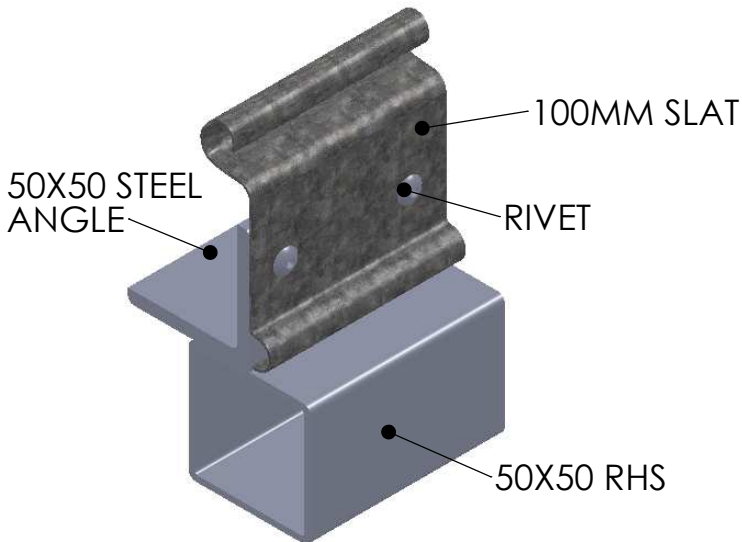

100MM BOTTOM RAILS

SCALE  
NTS

AUSTRAL MONSOON INDUSTRIES P/L  
50 Orchardleigh Street P.O. Box 294  
Yennora, nsw, 2161 Fairfield, NSW, 2165  
Australia Australia

DRAWN  
H.P.L.Y

Phone: +612 9892 3188 Fax: +612 9892 2167

DATE  
20/09/10

DWG No: AMI-ST0031B

*CONFIDENTIAL NOTE: This drawing and its designs, specifications and engineering information disclosed hereon are the property of AUSTRAL MONSOON INDUSTRIES P/L and are not to be disseminated or reproduced without express written consent. The drawing is loaned in confidence and then only for consideration of the matter hereon. In accepting loan of this drawing, the recipient agrees to keep it and the matter disclosed hereon in confidence and not to use nor permit their use in any way detrimental to AUSTRAL MONSOON INDUSTRIES P/L.*